

RANGE COOKER

**CMCF 96**



Dear customer

Congratulations on your choice of a Leisure quality cooker which has been designed to give you lasting service.

The cooker must be installed by a qualified technician in accordance with current regulations and used in a well ventilated space.

Please read these instructions thoroughly before installing or using - and keep for handy reference. Make sure you understand the controls prior to using your appliance. This cooker must only be used for its intended purpose, ie the cooking of food in the home. Failure to observe these instructions may invalidate your right to free service during the guarantee period.

If you have any questions, or if you are not sure about any information contained in this booklet please contact us - details are on the back cover.

Your Customer Service

---

## safety symbols

---

The use of any appliance and cookers in particular (which use high temperatures) require the following of basic common sense safety rules.

There is a danger of injury to the person and of damage to the cooker, the kitchen and your home.

These are itemised in the first section 'Safety in the home'. Where accidents are most common, we repeat these warnings in the main text using the following symbols:

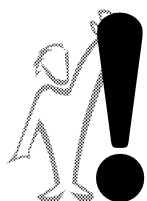

**Where you, other people, toddlers and children are at risk**



**Where there is a danger of damage to the cooker, utensils, surrounding areas and property**

Please note them for your own safety.

# contents

---



## **Introduction**

---

Welcome/Safety symbols	2
Safety in the home	4

## **Installation**

---

Know your cooker/specification	6
Electrical connection and location	7
Installation	8
Gas connection	9
Gas conversion	10

## **For the very first time**

---

Preparation and burning off	10
-----------------------------	----

## **Operating**

---

Operating the hob	11
Using the griddle	12
Saucepan types/deep fat frying	13
Operating the grill&top oven	14
Operating the multifunction oven	16
Operating the fan oven	19
Operating the timer	21

## **Cooker care**

---

Care & cleaning	24
Trouble shooting	25
Replacing the oven light	25
Future transportation	25
Guarantee & service	26

## Look after yourself, family and friends

This appliance is only to be used by persons who have been instructed on.



Its use to ensure their safety. Instruction or supervision should be given where necessary. Children should be supervised by a responsible person at all times.

- During use surfaces get hot. Don't touch hot surfaces during use.
- Close supervision while cooking is essential at all times.
- It is therefore advisable to have the glass secured against breakage in the household and personal effects insurance.
- When deep-frying, the appliance should be supervised as overheated fats and oils can catch flame easily. Never attempt to extinguish burning oil or fat with water (risk of explosion!). Smother a fire with wet towels and keep doors and windows closed!
- Special care should be taken when cooking oily and fatty food as overheating of such food can cause them to catch fire.
- Always use good quality oven gloves when removing hot utensils and the grill pan from the oven.
- Ensure handles of pans can not accidentally be caught or knocked and do not get heated by adjacent heating zones.
- Check all controls on the appliance are switched off after use.
- Take care when opening the door. Let steam and hot air escape before removing the food.
- Select the correct shelf position before turning the oven or grill on - don't move oven shelves when hot.
- Don't heat up unopened food containers as pressure can build up causing the container to burst.
- Don't store items above the cooker that children may try to reach.

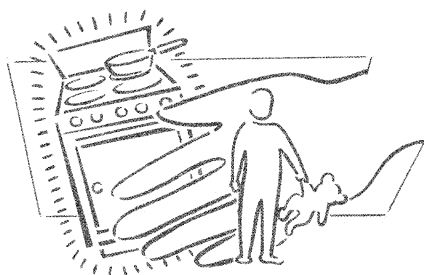
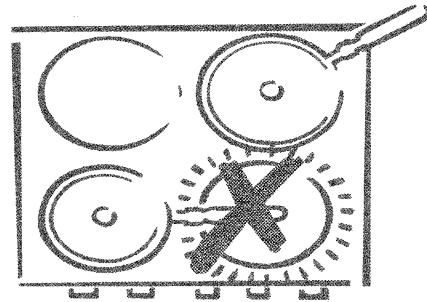

# safety in the home

---



## Look after your cooker and home

- Clean your cooker regularly, ideally after each use. Always turn off the mains electricity supply and allow the appliance to cool first.
- Spillage should be dealt with as soon as it occurs, taking due care as the hob surface may be hot. Any spillage left on the surface after cooking should be cleaned off before the hob is switched on again to prevent baking on.
- Don't use biological washing powder or bleach products, harsh abrasives or chemical cleaners for cleaning the oven inner panels.
- Don't allow anyone to sit or stand on the cooker or door.
- Don't move the cooker by pulling by the door and/or handle.
- Don't use large preserving pans or fish kettles across the hob as this will damage the ceramic hob.
- Ensure that no flammable materials are adjacent to the cooker as the sides become hot during use.
- Don't store flammable materials, aerosols etc in adjacent cabinets.
- Don't place flammable or plastic items on or near the hob, and never place wet cloths etc. on the hob to dry.
- Keep all ventilation slots clear of obstructions.
- Don't leave a hob on for long periods when not covered by a pan.
- Don't cover shelves with metal foil as the air circulation in the oven will be disrupted.
- Don't place dishes, pans and/or trays directly on the oven compartment base.
- Don't line the grill pan with aluminium foil. As this could result in an increase risk of fire or damage to your cooker.
- Don't use the cooker with glass panels removed.

## Don't use the cooker for

- Hanging towels and dish cloths etc on the handles.
- Warming plates under the grill.
- Heating the kitchen.
- Drying.
- Storage of inflammable materials or liquids in the storage compartment.

## Food hygiene

- Ensure meat and poultry is thoroughly defrosted before cooking.
- Check food is thoroughly cooked and is piping hot.
- **Always refer servicing to a qualified appliance service engineer.**



**This appliance is only to be used by persons who have been instructed on its use to ensure their safety. Instruction or supervision should be given where necessary. Children should be supervised by a responsible person at all times.**

**Do not operate hob without pans.**

**This product is designed only for domestic use.**

# know your cooker

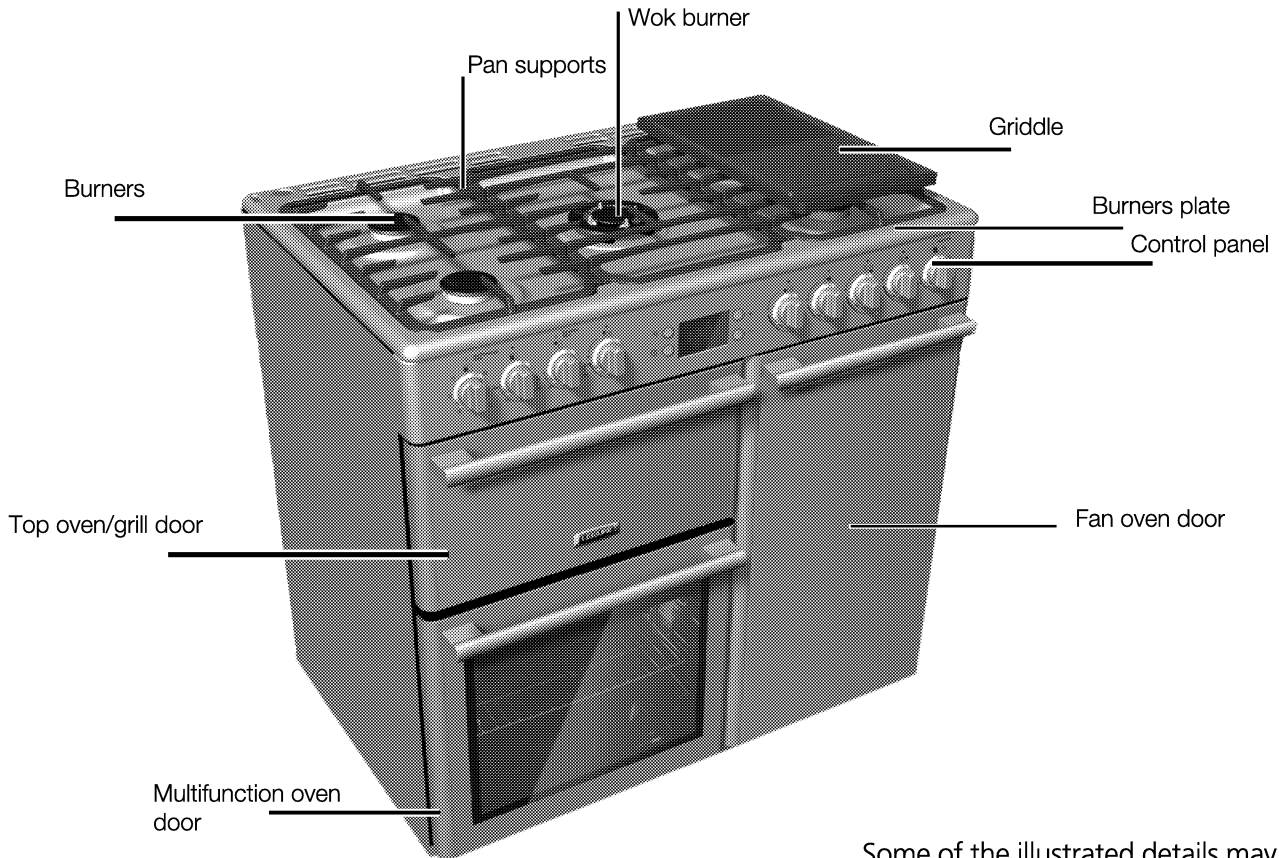

Some of the illustrated details may vary

## specification

External dimensions width x depth x height	
900mm x 600mm x 900mm	
Front-right burner	1.0 kW
Rear-right burner	2.9 kW
Front-left burner	2.0 kW
Rear-left burner	2.0 kW
Centre (Wok) burner	3.6 kW
Supply voltage	220-240V~; 50Hz
Top oven -conventional wattage	1025 W
Top cavity grill wattage	2025 W
Left hand side main-multi oven wattage	1950 W
Right hand side tall fan oven wattage	2150 W
Main cavity grill wattage	1600 W
Lamp	15 W x 3
Total power (gas)	11.5 kW
Total power (electric)	6200 W

Injector size	Injector marking	
	G 20, 20 mbar	G 30, 28-30 mbar
Rapid burner	115	87
Auxiliary burner	72	50
Semi-Rapid burner	103	72
Wok burner	133/147	96

Ignition	Auto electric on all burners
Safety device	Gas valves are lockable/Flame supervision devices on all burners.

Gas	Supply Pressure	Destination Countries
G20	20 mbar	GB, IE
G30	30 mbar	GB, IE
G31	37 mbar	GB, IE

I2H AT 20 mbar and I3P AT 37 mbar  
I 3B/P 30 mbar

Cat II<sub>2H3P</sub>, Cat II<sub>2H3+</sub>,

For Cooker set up condition please refer to rating label

Because we continually strive to improve our products, we may change our specifications and designs without prior notice.

### Accuracy

Note that times and temperatures in this book are for guidance only.

# electrical connection

- Do not connect the cooker to the electricity supply until all packing and transit protectors have been removed.
- Before your appliance is connected to the mains electricity supply, check to ensure that the voltage and frequency shown on the rating label corresponds with your power supply. The label is located on the plinth below the oven door.
  - This product must only be installed by a qualified electrician** eg local electricity company or NICEIC registered contractor to a suitable double-pole control unit with a minimum contact clearance of 3mm in all poles and with a minimum rating of 32A which should be fitted adjacent to (but not above) the cooker in accordance with IEE regulations. **Failure to observe this instruction may result in operational problems and invalidation of the product warranty.**
  - Access to the mains terminal is gained by removing the small rear cover. The cable must have conductors of sufficiently high cross sectional area to prevent overheating and deterioration. Recommended cross-section area is six square millimetres (6.00 mm<sup>2</sup>). The mains cable must conform to BS6004.
- This appliance must be earthed.**

- The mains cable must pass through the cable clamp.
  - The mains cable should be routed away from the appliance and in particular ventilation slots, the vent outlet and should not be obstructed when pushed in to position between the appliance and the wall and/or cabinets.
- The appliance conforms to BS 800: 1988 and EEC directive 87/308 regarding suppression of radio and television interference.
  - Type with regard to protection against overheating of surrounding surfaces=X.

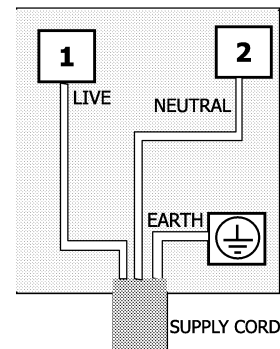

## Mains cable routing

The mains cable should be routed away from the appliance, the ventilation slots and the vent outlet. It should not be obstructed when pushed in to position between the appliance and the wall.

# location

- Excess steam from the oven is expelled at the rear of the appliance therefore the wall behind the cooker needs to be protected against grease and moisture.
- The cooker is designed to fit between kitchen cabinets spaced over 900 mm apart. The space either side of the cooker need only be sufficient to allow withdrawal of the cooker for servicing. It can be used with cabinets on one side or both sides as well as in a corner setting. It can also be used free-standing.
- Adjacent side walls above the appliance must not be nearer to the cooker than 65mm and should be of heat resistant material. Leave at least 750 mm clearance above the hob to a cooker hood and 600mm to any cabinet.

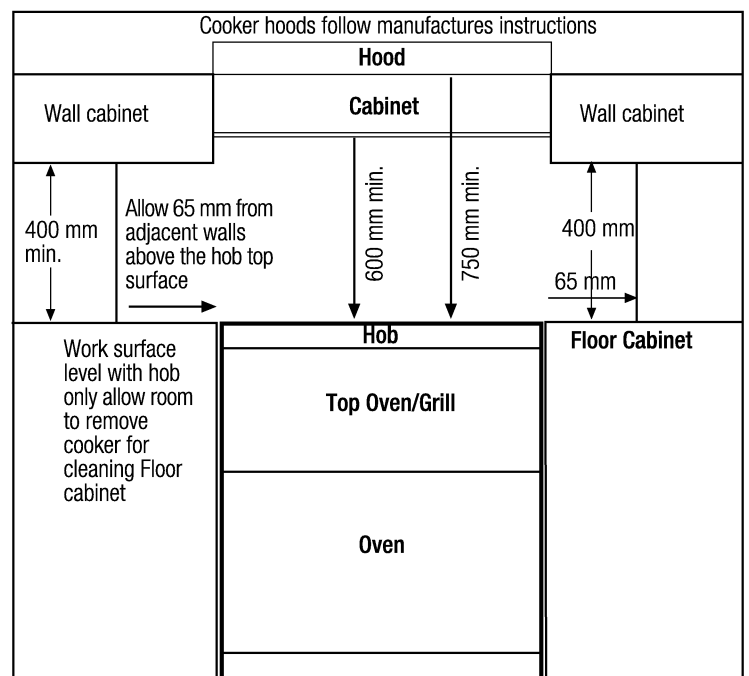



## Unpacking

All packing materials, protective film and transit protectors must be removed.

## Installers



**The appliance must only be installed by a competent person.**

In the UK, Gas Safe registered installers (including the Regions of British Gas) undertake to work to safe and satisfactory standards.

## Regulations

The cooker must be installed in accordance with the Gas Safety (Installation and Use) Regulations and the relevant Building Regulations in force.

## Levelling

The appliance should be located on a level surface. The two front and rear feet can be adjusted as required. To ensure that your appliance is standing level adjust the two front or rear feet by turning clockwise or anticlockwise until the product is in firm contact with the floor.

The installation instructions for cooking ranges that are placed on the floor shall state that if the range is placed on a base, measures have to be taken to prevent the appliance slipping from the base.

## Stability Chain

The cooker must be secured by the security chain to the wall or partition behind the cooker.

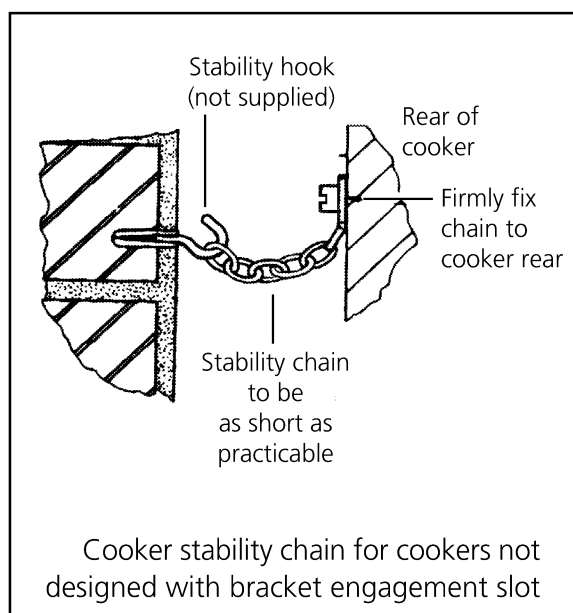

## Moving your cooker

If your cooker is fitted with a flexible hose the cooker can be moved for cleaning. Make sure that the floor covering is firmly fixed or removed to prevent it being disturbed.

**TAKE CARE NOT TO STRAIN OR DAMAGE THE GAS HOSE (OR ELECTRICITY SUPPLY CABLE) WHEN MOVING THE COOKER.**

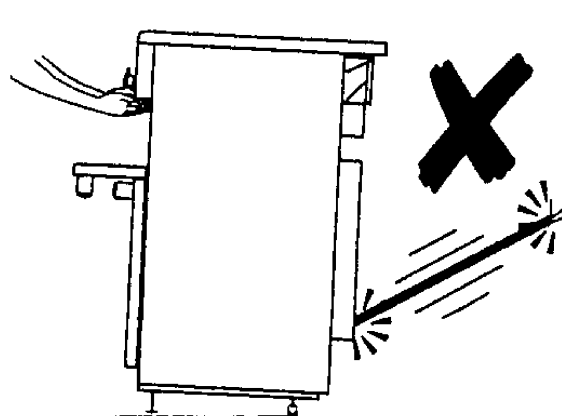

Release the stability chain as you ease the cooker out. Don't forget to refit it when you replace the cooker.

Lift the front feet clear off the floor by lifting at the ends of the hotplate fascia. Do not move by pulling the door handle or knobs.

Move the cooker a bit at a time, checking behind it to make sure that the gas/electric connection has sufficient slack to allow the cooker to move forward as you go along.

When you replace the cooker, again check behind to make sure that the gas hose or cable are not caught or trapped. Take care not to twist it within the gap between the kitchen units as damage may occur to the cooker or the units.

Check that the cooker stability chain has been reconnected.

# gas connection

## Gas supply

Your oven must only be used on natural gas or LP gas.

## Natural Gas

The cooker is designed for UK and Ireland installation using a flexible connection with tubing in accordance with the regulations in force. Length of 900mm is recommended (Ireland 600 mm).

## LP Gas

For flexible connections use a bayonet type hose, suitable for use on LP Gas up to 50 mbar pressure rise. The flexible hose should be coloured black with a red stripe, band or label.

## Gas flexible hose

If a flexible hose is used it must not come into contact with the top 150mm/6 inches (the shaded area on the diagram) of the rear of the appliance.

Do not pass the hose through the hot region behind the oven.

## Connection

Connect the flexible gas hose to the oven as follows.

- 1 Use nonsetting gas sealant on the connection to the cooker.
- 2 Connect to the gas supply pipe at the rear of the cooker (1/2 in BSP).
- 3 Assemble burner caps and rings fit pan supports in position. (left and right sides)
- 4 Turn on the gas supply and check for soundness.
- 5 Light two burners and check that the pressure is correct.



## Gas leaks

**If you smell gas, turn off all gas controls and extinguish any open flame. Open a window to ventilate the room. Don't touch any electrical switches. Contact your local Gas Supplier immediately.**

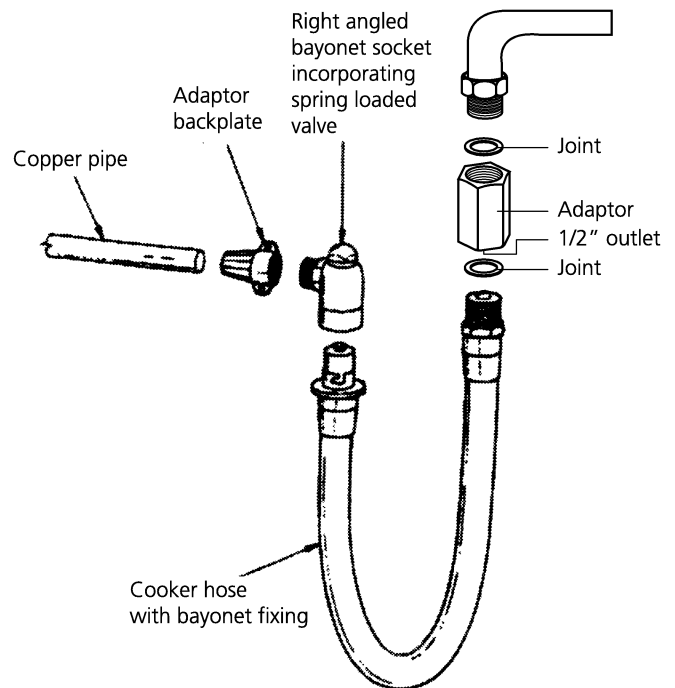
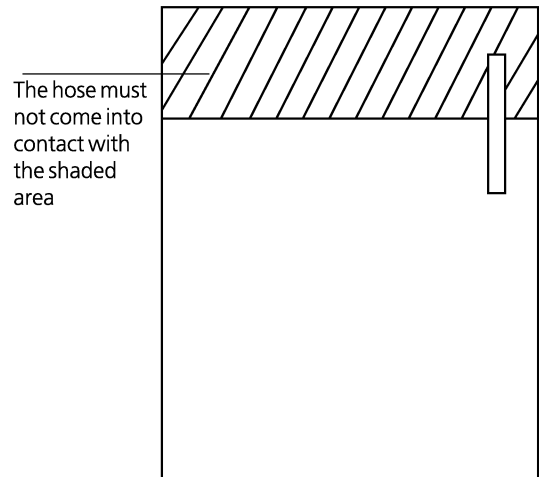

**Ensure that the local distribution and adjustment conditions are compatible.  
Check the rating plate to identify cooker preset condition.**

## Conversion from natural gas to LPG

**The conversion must only be implemented by a qualified engineer.**

1. Replace the natural gas orifices by the LPG equivalents.
2. Check gas soundness.
3. Remove the control knobs.
4. Adjust the reduced rates of the burners.

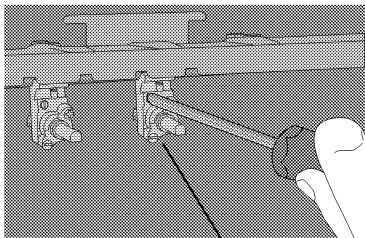

**A: Hob burner tap**

### **A. Hob burners**

- \* Adjust screw "A" 1-1 1/2 turns clockwise to obtain flame length of about 5 mm.
- \* Adjust each burner separately.

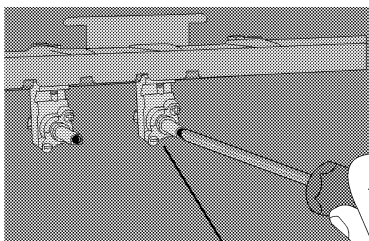

**A: Hob burner tap**

### **A. Hob burners**

- \* Adjust screw "A" 1-1 1/2 turns clockwise to obtain flame length of about 5 mm.
- \* Adjust each burner separately.

## Conversion from LPG gas to NG

**The conversion must only be implemented by a qualified engineer.**

1. Replace the gas orifices by the NG equivalents.
2. Check gas soundness.
3. Remove the control knobs.
4. Adjust the reduced rates of the burners.

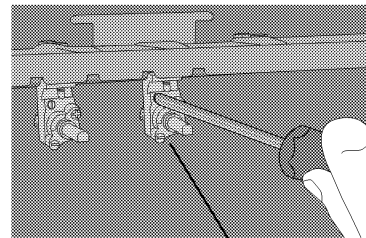

**A: Hob burner tap**

### **A. Hob burners**

- \* Adjust screw "A" 1-1 1/2 turns anti clockwise to obtain flame length of about 5 mm.
- \* Adjust each burner separately.

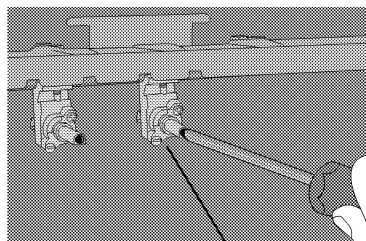

**A: Hob burner tap**

### **A. Hob burners**

- \* Adjust screw "A" 1-1 1/2 turns anti clockwise to obtain flame length of about 5 mm.
- \* Adjust each burner separately.

### **5. Apply the following labels;**

- \* Overstick current rating plate with modified cut out label ensuring serial number is still visible.
- \* Tick appropriate LPG gas box and fix adjacent to the rating plate label.

### **5. Apply the following labels;**

- \* Overstick current rating plate with modified cut out label ensuring serial number is still visible.
- \* Tick appropriate NG gas box and fix adjacent to the rating plate label.

# preparation and burning off



## **Important for asthmatic sufferers**

Before using for the first time, protective coatings need to be burnt off. Fumes will be emitted but this is quite normal.

**Ensure the room is very well ventilated during the burning off process. Avoid directly inhaling the fumes during this process.**

## **Grill**

Open the grill door. Remove wire rack, baking tray and handle, and set the control to 150  for about 15 minutes.

## **Oven/s**

Remove shelves and baking tray and turn the oven control knobs to 200°C for about 15 minutes.

## **Cleaning**

Before you start using your cooker, clean the appliance as recommended under Care and cleaning on page 22.

# operating the hob

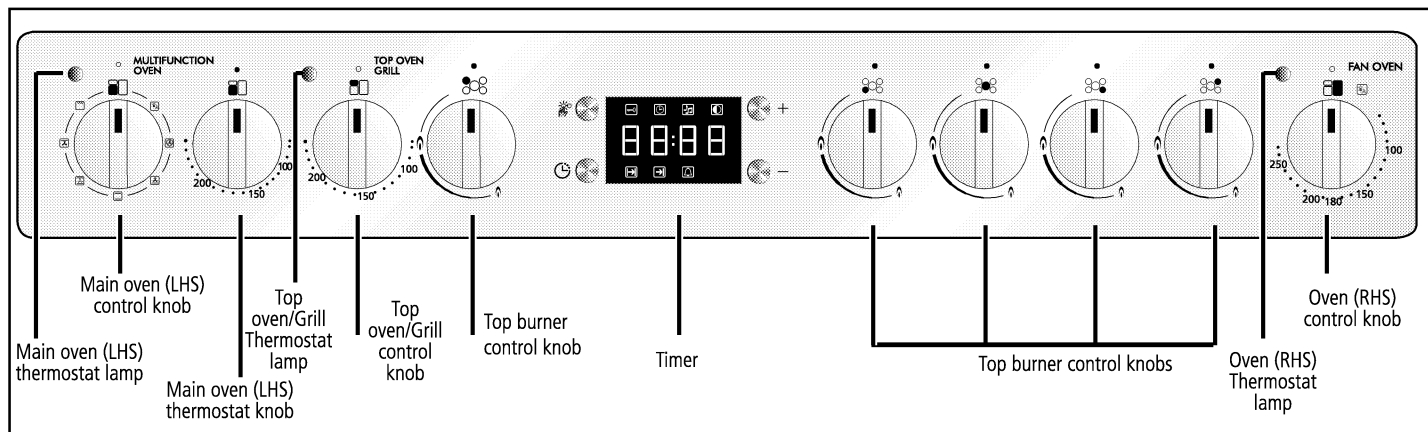

## Turning on and off

### Flame Failure Device

All burners are protected by flame failure devices, if the flames are extinguished for any reason the gas will automatically be cut off.

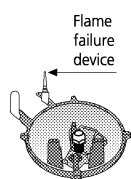

The burner control knobs have a safety feature.

1 Push the appropriate knob in slightly and turn anti-clockwise to the required setting.

2 Keep the knob depressed for 15 seconds after the burner has lit to override the safety device.

After you release the knob, if the ignition does not continue repeat the same process by keeping the knob pressed for 15 seconds. If still no ignition occurs, wait for 1 minute and repeat again.

**Warning: Do not keep the knob in pressed position more than 15 seconds.**

3 To switch a burner off turn the corresponding knob to ● (upright) position.

- Turning the control knob fully anti-clockwise to the small flame symbol enables you to simmer without accidentally switching off.

## Wok Burner

- The wok burner is used for rapid cooking. In particular for cooking of sliced vegetables and meat in a very quick time period.

A wok frying pan is a wide and shallow pan which conducts heat rapidly allowing cooking of vegetables and meat evenly at the same temperature, ensuring that their original nourishment value is maintained.

## Flame control

- When turning on a hotplate burner, stay and make sure that it has lit, and adjust the flame immediately.
- **Selection of the correct flame height is especially important to safety.** Adjust the burner flame so that it does not extend beyond the bottom of the pan, any higher and the flame becomes inefficient and can be a potential fire hazard.
- To make sure that the cooker is operating safely, periodic checks are advised.
- At low settings, do not leave the burners unattended for long periods of time.
- The burner flames should burn with a visible bluish cone within the main flame, and with no sign of yellowness. If at the first lighting they are very noisy and yellow, turn out at once and check that the burner cap has been correctly replaced. If on re-lighting there is no improvement, ask your supplier to check them. The inner portions of the flames as described above may not be very clear, but this is not detrimental in anyway.

The pan supports are not interchangeable.

# using the griddle



## Parts will become hot when the griddle is in use, children must be kept away.

- The griddle fits on a single pan support, front to back. It is designed for cooking food on directly. Don't use pans of any kind on it. The griddle surface is non-stick and metal cooking utensils (e.g. spatulas) will damage the surface. Use heat resistant plastic or wooden utensils.
- Don't put it crossway's - it will not fit properly and will be unstable.
- Always leave space around the griddle for the gases to escape. **Never** fit two griddles side by side. Large pans should also be spaced well apart. The maximum pan base diameter is 22cm (8.5 inches).
- Position the griddle over the hotplate burners resting on a pan support. The griddle can be lightly brushed with cooking oil before use. Light the hotplate burners. Adjust the flame heights to suit.
- Preheat the griddle for a maximum of 2 minutes before adding food. Leaving it longer may cause damage. The controls can be turned to a lower position simply by turning the control knobs towards the lower position marked with the small flame symbol.
- Only use a Leisure Consumer Products Griddle, use of alternative types could result in a risk to safety.
- Clean with warm soapy water never wash in a dishwasher. Never use any sharp instruments, abrasive cleaners or oven cleaner. Otherwise the nonstick surface will be damaged.

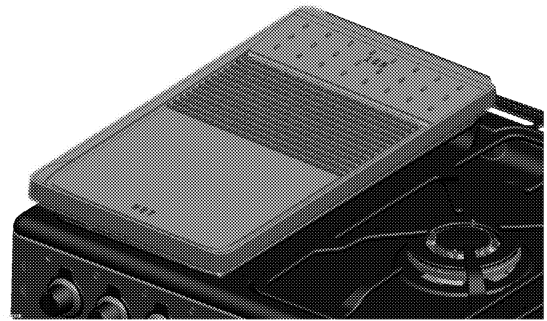

## Griddle Cooking Chart

- Personal experience will soon familiarize you with the correct setting to use for cooking. As a guide refer to the cooking chart below.
- After cooking allow the griddle to cool before cleaning.

Preheat for 2 minutes before cooking.

<u>Type of food</u>	<u>Heat Setting</u>
Drop Scones	High-Medium-Low
Bacon	High-Medium-Low
Chops	High-Medium-Low
Steak	High-Medium-Low
Burgers	High-Medium-Low
Potato Cakes	Medium-Low
Eggs	Medium-Low
Fish Cakes	Medium-Low

# saucepans

## Pan choice

In choosing pans, look for pan handles that can be held easily and will stay cool. Avoid pans that are unstable and easily tipped. Pans that are too heavy to move easily when filled can also be a hazard. Only use flat bottomed pots or pans.

## Pan size

For maximum efficiency and safety, use the recommended pan sizes for each burner.

- Use pans which have sufficient capacity for the amount of food being cooked so they don't boil over and cause unnecessary cleaning.
- Do not place lids on the burners.

Always position pans centrally over the burners. When transferring pans from one burner to another always lift the pans do not slide them.

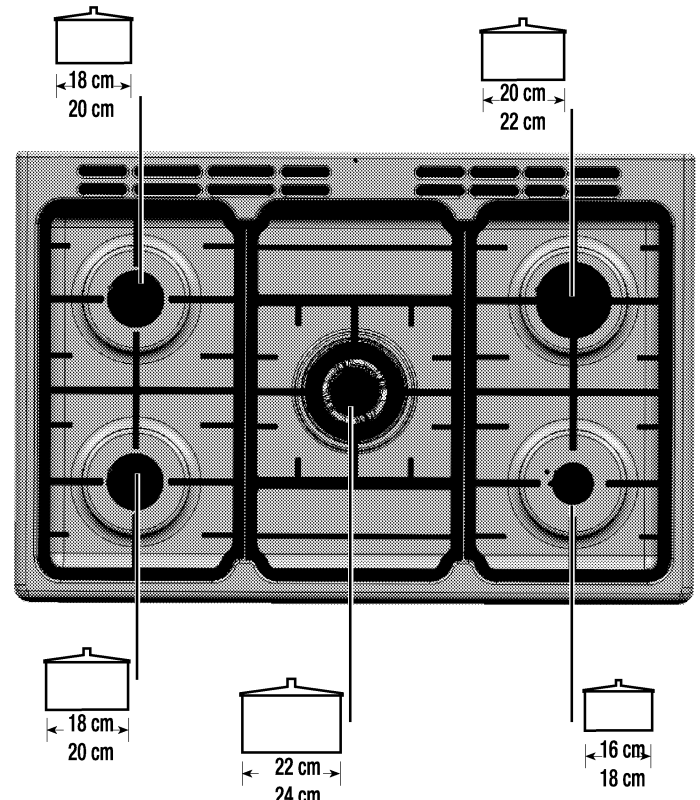

# deep fat frying



- Never fill the pan more than the one-third full of fat or oil.
- Never leave unattended during heating or cooking.
- Do not fry too much food at the same time especially frozen food. This only lowers the temperature of the oil or fat too much resulting in greasy food.
- Always dry food thoroughly before frying and lower it slowly into the hot oil or fat. Frozen foods in particular will cause frothing and spitting if added too quickly.
- Never heat fat or fry with a lid on the pan.
- Keep the outside of the pan clean and free from streaks of oil or fat.

## In the event of a chip pan or other pan fire

- 1 Turn off the cooker.
- 2 Smother flames with a fire blanket or damp cloth.
- 3 Do not try to remove a burning pan from the hob.

Burns and injuries are caused almost invariably by picking up the burning pan and rushing outside with it.



**Do not use water on the fire.**  
**Leave the pan to cool for at least 30 minutes.**

# operating the grill/top oven

 **Parts may become hot when the grill/top oven is in use, children must be kept away.**

A switch operated by the door changes the heating element configuration between grill and oven operation. When the door is open, the top element is activated for intense downward heat; when the door is closed, the top (operating at 50% of the grilling power) and lower elements are activated to provide even oven heating.

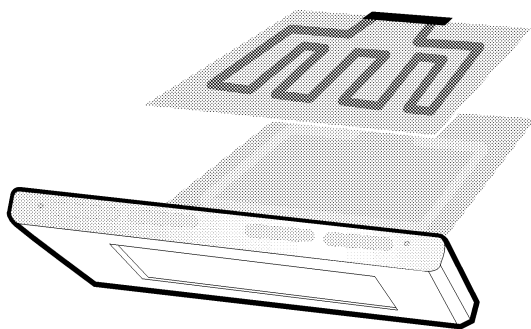

**As a grill**  
door open

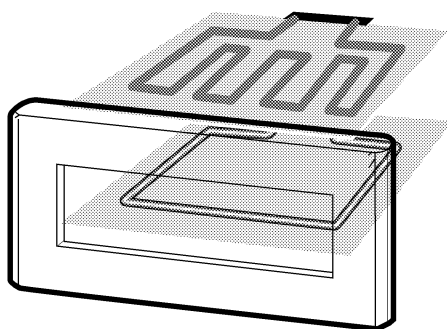

**As an oven**  
door closed  
with lower concealed element

## Using as a grill

When the door is fully open, it remains tilted slightly, so that any spillage will be directed away from you.

**1** Open the door.

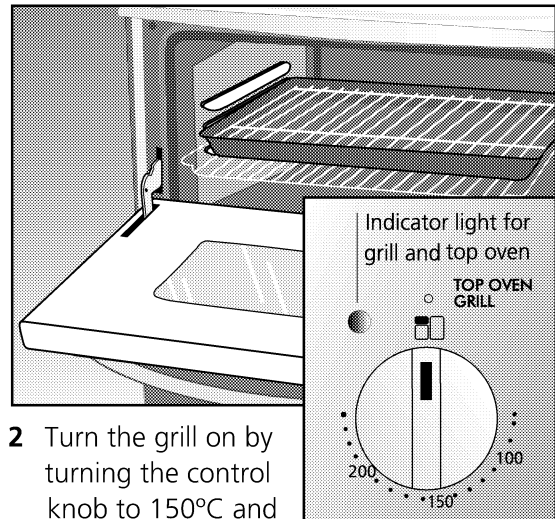

**2** Turn the grill on by turning the control knob to 150°C and allow to preheat for around 5 minutes.

**3** The indicator light will glow to show that the grill has been switched on.

- Only use the middle and bottom rack position for grilling. Do not use the top position.
- Ensure the food is correctly positioned under the grill element.
- Food which requires browning only should be placed under the hot grill, either in the grill pan, or on the floor of the grill compartment, according to the depth of the dish. The grill pan wire grid can be removed.
- Do not line the grill pan with aluminium foil.
- Plates and dishes placed on the floor of the grill compartment will be heated when the main oven is in use.
- Do not switch on the grill when using the compartment for storage.

## Grilling guidelines

Use the 240° position for toast, for sealing and fast cooking of foods.

For thicker foods requiring longer cooking, turn the control to a lower setting after the initial sealing on both sides. The thicker the food, the lower the control should be set. When grilling thicker food, the grill rack should be turned over to its lowest position.

## Using as an oven

- 1 Turn the oven on by rotating the top oven control knob clockwise.
- 2 Select the temperature in the oven by selecting the temperature (in degrees Celsius) printed on the control panel .
- 3 The amber temperature indicator light on the control panel will glow until the pre-set temperature is reached.
- 4 Once the temperature has been reached, the amber light will go off and then cycle on and off to maintain the pre-set temperature.
  - Take care when opening the door. Let steam and hot air escape before removing the food.

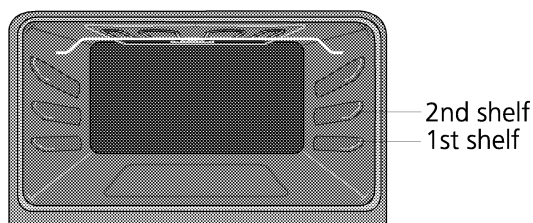

### Top oven temperature chart

This chart is for guidance only, follow food manufacturers recommendations whenever available.

There is a temperature conversion chart in the next Fan Oven section.

Food	Cooking temperature °C	Time	Shelf position
Beef	170-180	30 mins per 450g +30 mins	1
Lamb	180-190	30 mins per 450g + 30 mins	1
Pork	170-190	40 mins per 450g + 40 mins	1
Poultry	170-190	25-30 mins per 450g + 25 mins	1
Casseroles	140-160	1.5-2 hours dependent on quantity	1
Fruit cake	140-160	Time dependent on size	1-2
Small cakes	160-180	20-25 mins	2
Victoria sandwich	160-180	20-25 mins	1

Please note that times and temperatures in this book are for guidance only.



# operating the main oven (multifunction)-(LHS)



**Don't touch the heating elements or other parts that may become hot when the oven is in use children must be kept away!**

**The timer only controls this oven part.**

### Warning

**The clock controls the oven heating elements and the current time of day must be set before the oven will operate.**

- 1 Turn the oven on by rotating the oven control knob to desired position.
- 2 Select the temperature in the oven by selecting the temperature (in degrees Celsius) printed on the control panel.
- 3 The amber temperature indicator light on the control panel will glow until the pre-set temperature set is reached.
- 4 Once the temperature has been reached, the amber light will go off and then cycle on and off to maintain the pre-set temperature.

**Ensure you stand back from the appliance when opening the oven door to allow any build up of steam or heat to escape.**

- Check food is thoroughly cooked and is piping hot.
- As a fan oven heats up more quickly and generally cooks food at a lower temperature than a conventional oven, preheating the oven is often unnecessary. However, food such as bread, scones, Yorkshire pudding, do benefit from being placed in a pre-heated oven.

### Shelf positions

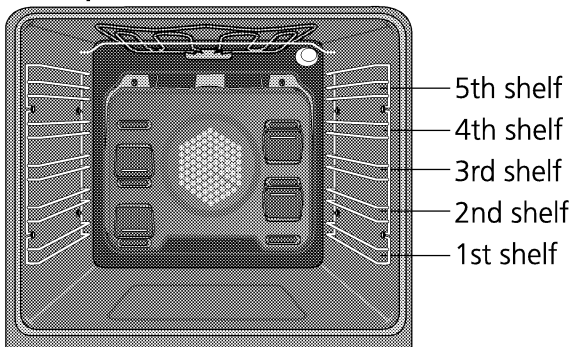

### Important

Level 1 is the bottom level in the oven.

### The stages of the function selection knob



Fan and oven lamp are on.



Fan and ring heater are on. The hot air is distributed evenly and quickly all over the oven by the fan. Suitable when several levels are used for the preparation of food.



In this position you can cook by operating the bottom resistance and turbo fan according to the characteristics of the meal you cook.



Top and bottom heaters are on. The food is heated equally from the top at the bottom. Suitable e.g. for cakes in baking moulds and casseroles.



Top and bottom heaters with fan are on. The food is heated equally from the top at the bottom. Therefore, we recommend to cook food which has the same cooking temperature at the same time. Suitable e.g. for cakes in baking moulds and casseroles.













Top heater with fan are on. You can use this position to fry to top of your meal better.



Grill  
Before performing grilling, make sure to oil the grill with cooking oil.

## Cooking table



FOODS	COOKING PLATE	SHELF POSITIONS			THERMOSTAT POSITION	COOKING TIME (min)		
		 Fan with Turbo heater	 Top and bottom	 Top and bottom+fan		 Top and bottom+fan	 Fan with Turbo heater	 Top and bottom
Short bread	24-26 cm bread mould	2	3	2	170-180	20-30	15-25	25-35
Cake in tin	18-22 cm cake mould	2	3	2	170-180	20-30	20-30	25-35
Cookie	Baking sheet	3	3	3	170-190	20-25	20-30	25-35
Pastry	Baking sheet	3	3	3	 :180-190	30-40	35-45	40-50
					 :190			
Yeasted dough	Big tray	3	3	3	 :190-200	30-35	25-35	35-45
					 :200			
Biscuits	Cooking sheet	3	3	3	170-180	15-20	15-25	20-30
Cake	Baking sheet	3	3	3	170-180	25-35	20-30	25-35
Lasagne	Lasagne dish	3	3	3	170-180	35-45	35-45	40-50
Pizza	Baking sheet	3	3	3	200-220	25-30	20-30	30-35
Roast beef	Roasting dish	3	3	3	240(15 min)	105-115	90-120	110-120
Lamb shoulder	Roasting dish	3	3	3	240(15 min)	65-85	65-80	70-90
Roasted chicken	Roasting dish	3	3	3	240(15 min)	55-65	55-65	60-70
Roasted turkey (5,5 kg)	Baking sheet	3	3	3	220(25 min)	175-230	170-220	180-240
Fish	Roasting dish	3-4	3	3	200	10-20	15-20	15-25

### Important

For roast meats start with highest thermostat level and decrease to 150°C after 15 minutes.

- The values listed in the table are the results obtained from laboratory testing.
- You may find different flavors of the food according to your own cooking and usage practices.
- If you wish, you can add the time it takes to pre-heat the oven to the values listed in the table.

Shelf position (In fan with Turbo heater oven)  
 For 3 trays : 1 - 3 - 5  
 For 2 trays : 3 - 5  
 For 1 tray : 3

-  Fan with turbo heater
-  Top and bottom heater
-  Top / bottom heater & fan

### Temperature conversion

The oven temperature control panel is marked in degrees Celsius (sometimes called Centigrade). This chart will help when recipes show °F or use descriptive terms (as recommended by the Association of Manufacturers of ..... Electrical Appliances).

# operating the grill (LHS)

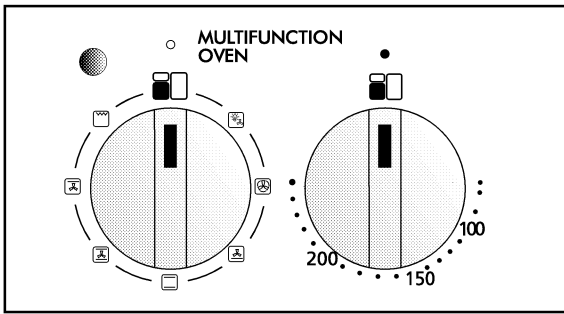

## Using as a grill



**Parts may become hot when the grill is in use, children must be kept away.**

- Turn the grill on by rotating the oven control knob to  (grill setting) position.
- Set the grill control to maximum temperature in the oven.
- ☛ Apply oil on the grill tray rack to prevent meat from sticking on the bars.
- ☛ For easy cleaning put some water in it.
- Ensure the food is correctly positioned under the grill element.
- CLOSE the door.
- Food which requires browning only should be placed under the hot grill, either in the grill pan. The grill pan wire grid can be removed.
- Do not line the grill pan with aluminium foil. As this will result in an increase in temperatures a risk of fire/ damage to your appliance.
- Do not switch on the grill when using the compartment for storage.
- During grilling operation constant supervision is required.

# operating the fan oven (RHS)

1 Turn the oven on by rotating the oven control knob clockwise.

2 Select the temperature in the oven by selecting the temperature (in degrees Celsius) printed on the control panel.

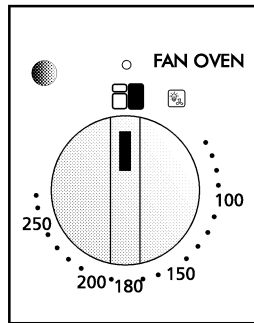

3 The amber temperature indicator light on the control panel will glow until the pre-set temperature is reached.

4 Once the temperature has been reached, the amber light will go off and then cycle on and off to maintain the pre-set temperature.

## DEFROST FUNCTION

For defrost function, align knob indicator with defrost symbol (Fan/lamp icon).

**NOTE: DO NOT TURN KNOB PAST THIS POSITION FOR DEFROST AS FAN ELEMENT WILL BE ACTIVATED.**

Ensure you stand back from the appliance when opening the oven door to allow any build up of steam or heat to escape.

- Check food is thoroughly cooked and is piping hot.
- As a fan oven heats up more quickly and generally cooks food at a lower temperature than a conventional oven, preheating the oven is often unnecessary. However, food such as bread, scones, Yorkshire pudding, do benefit from being placed in a pre-heated oven.

## Plate warming rack

Please be sure that plate warming rack is mounted to the inner rack (see fig.).

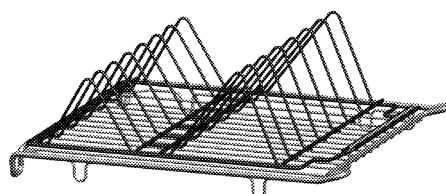
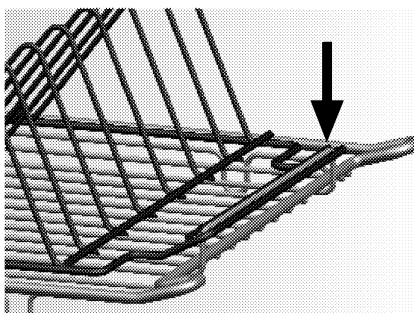

## Shelf positions

### Important

Level 1 is the bottom level in the oven.

### Recommended cooking levels:

For 1 tray use 4 or 6th level.

For 2 trays use 4 and 6th level.

For 4 trays homogeneous cooking use 2-4-6-8 levels.

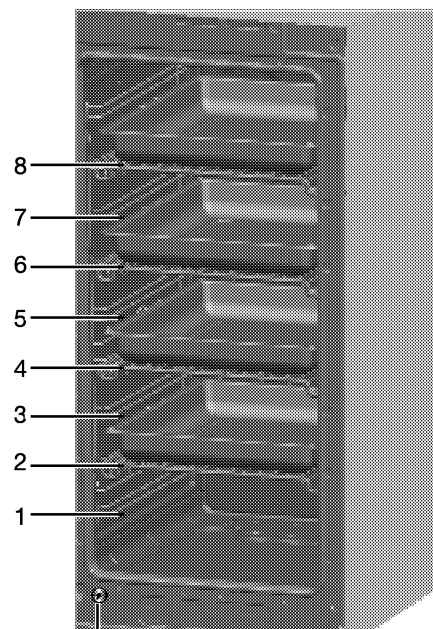

### Lamp button

When the door is open, oven lamp is lit.

## Fan oven temperature chart

This chart is for guidance only, follow food manufacturers recommendations whenever available.

### Temperature conversion

The oven temperature control panel is marked in degrees Celsius (sometimes called Centigrade). This chart will help when recipes show °F or use descriptive terms (as recommended by the Association of Manufacturers of Domestic Electrical Appliances).

Description	Celsius °C	Fahrenheit °F
Cool	70	150
	80	175
	100	200
	110	225
Slow	120	250
	140	275
	150	300
Fairly hot	160	325
	180	350
Hot	190	375
	200	400
Very hot	220	425
	230	450

Food	Cooking temperature °C	Time	Shelf position
Beef	160-180	20-25 mins per 450g +20 mins	4-6
Lamb	160-180	25 mins per 450g + 25 mins	4-6
Pork	160-180	25 mins per 450g + 25 mins	4-6
Poultry up to 4kg (8lbs)	160-180	18-20 mins per 450g + 20 mins	4-6
Poultry up to 5.5kg (12lbs)	150-160	14-16 mins per 450g + 20 mins	4-6
Casseroles	140-150	1.5-2 hours dependent on quantity	4-6
Fruit cake	130-140	Time dependent on size	4-6
Small cakes	160-180	20-25 mins	4-6
Victoria sandwich	160-180	20-25 mins	4

### Important

The values specified have been determined in the lab. The values suitable for you may deviate from the values.

# operating the timer (Main oven - LHS)

## Initial operation

Before first usage of your appliance, don't forget to remove the sticker on the digital timer screen.



### Setting the time

#### Important

**The Timer control only the left hand side-main oven.**

Before using the oven the timer must be set. If the timer is not set, the main oven will not work.



#### Notice

While making any adjustment, related symbols on the clock will flash.

After switching on the oven for the first time, adjust the current time with keys **5** and **6**.

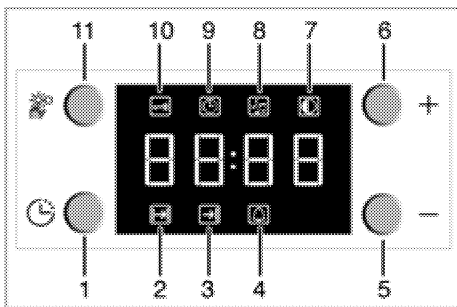

- 1 Program knob
- 2 Cooking time
- 3 Cooking end time
- 4 Alarm period
- 5 Minus key
- 6 Plus key
- 7 Screen brightness adjustment
- 8 Alarm volume
- 9 Current time
- 10 Keylock
- 11 Adjustment key

After setting the time, you can start and end of the cooking by selecting the desired position with temperature button and function button.



#### Important

If the current time is not set, time setting will start increasing/moving up from 12:00. Clock icon '9' will be displayed to indicate that the current time has not been set. This icon will disappear once the time is set.

#### Important

Current time settings are cancelled in case of power failure and will need to be set again.

## Changing the time of the day

In order to change a preset time of the day in your oven;

1. Press key **11** to activate current time icon '9'.
2. Adjust hour of the day using keys **5** and **6**.

## Changing screen brightness adjustment

1. Press key **11** to activate screen brightness symbol '9' for screen brightness adjustment.
2. Adjust the desired brightness using keys **5** and **6**.
  - Selected brightness level will be displayed as **d-01**, **d-02** or **d-03** on the screen.

## How to operate the oven timer



#### Important

The maximum time to be set for the end of the cooking process is 23 hours and 59 minutes. In case of power cut, program will be canceled. Reprogram is needed.

#### Notice

While making any adjustment, related symbols on the clock will flash. You must wait for a short time for the settings to take effect.



#### Important

If semi-automatic or full automatic operation mode is set on the clock, time of the day cannot be adjusted.

#### Notice

Cooking time will be displayed once the cooking starts.

## Switch on fully automatic operation

In this operation mode you may adjust how long the oven will automatically operate (cooking time) and the time it will be automatically turned off (end of cooking time).

1. Press **1** key to activate cooking time symbol (**2**).
2. Adjust the cooking time using keys **5** and **6**.
  - Cooking symbol will be on (will be displayed continuously) after cooking time is set.
3. For the cooking end time, press **1** key to activate cooking end time symbol '**3**'.
4. Adjust cooking end time using keys **5** and **6**.
  - Once the cooking end time is set, cooking end symbol and cooking symbol will be lit (displayed continuously). The end of cooking time symbol (**3**) will disappear as soon as the cooking has started.
5. Place your dish in the oven.
6. Select operation mode and temperature.

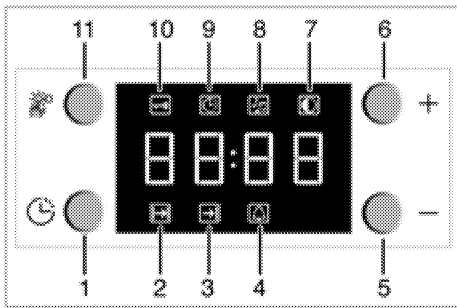

- 1 Program knob
- 2 Cooking time
- 3 Cooking end time
- 4 Alarm period
- 5 Minus key
- 6 Plus key
- 7 Screen brightness adjustment
- 8 Alarm volume
- 9 Current time
- 10 Keylock
- 11 Adjustment key

- Oven timer automatically calculates the startup time for cooking by using the end of cooking time you have set and the cooking period. Selected operation mode is activated when the startup time of cooking has come and the oven is heated up to the set temperature. It maintains this temperature until the end of the cooking time.

- 7. After the cooking process is completed, "End" symbol will be displayed and the alarm signal will sound.
- 8. Alarm signal will be on for 2 minutes. To stop the alarm signal, just press any key.



**Important**

If you mute the alarm by pressing any key, the oven will restart operating. If you press any button at the end of the alarm period, the oven will restart operating.

Alarm will be silenced and current time will be displayed.

- 9. Do not forget to turn off the oven using temperature knob and function knob.

**Switch on semi-automatic operation**

In this operation mode, you may adjust the time period during which the oven will operate (cooking time).

1. Press **1** key to activate cooking time symbol '2'.
2. Adjust the cooking time using **5** and **6** keys.
  - Cooking symbol shall be on (will be displayed continuously) after cooking time is set.
3. Place your dish in the oven.
4. Select operation mode and temperature.

The oven will be heated up to the preset temperature and will maintain this temperature until the end of the cooking time you selected.

5. After the cooking process is completed, "End" symbol will be displayed and the alarm signal will sound.
6. Alarm signal will be on for 2 minutes. To stop the alarm signal, just press any key.



**Important**

If you mute the alarm by pressing any key, the oven will restart operating. If you press any button at the end of the alarm period, the oven will restart operating.

Alarm will be silenced and current time will be displayed.

- 7. Do not forget to turn off the oven using temperature knob and function knob.

**How to use the program lock**

**Activate the program lock**

You can prevent using of clock buttons by activating the program feature.

**Notice**

When the keylock function is activated, clock buttons except for "11" key cannot be used.

1. Press '11' key to activate keylock symbol "10". "OFF" will be displayed.
2. Press **6** key to activate the keylock.

After the keylock has been adjusted, "ON" will be displayed and the keylock symbol will stay on.

**Deactivate the program lock**

1. Press '11' key to activate keylock symbol "10". "ON" will be displayed.
2. Press '5' key to deactivate the keylock.

"OFF" will be displayed after the keylock is turned off.

## How to use the alarm clock

In addition to using the timer for cooking, it can be also used as a reminder or an alarm clock.

As soon as the defined period of time has expired, the alarm clock will emit a signal. The alarm clock has no influence on the functions of the oven.

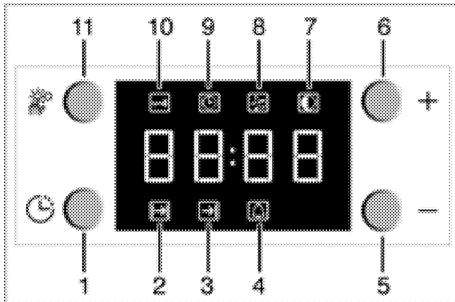

- 1 Program knob
- 2 Cooking time
- 3 Cooking end time
- 4 Alarm period
- 5 Minus key
- 6 Plus key
- 7 Screen brightness adjustment
- 8 Alarm volume
- 9 Current time
- 10 Keylock
- 11 Adjustment key

## Setting the alarm clock

1. Press **1** key to activate alarm time symbol (4).



### Important

The maximum alarm time can be 23 hours and 59 minutes.

2. Adjust the alarm time using 5 and 6 keys.

Alarm symbol will be on (will be displayed continuously) after alarm time is set, and the alarm time will be displayed.

3. After the alarm time is finished, alarm symbol will start flashing and an alarm signal is heard.

## Switching off the alarm

1. To stop the alarm signal, just press any key.

Alarm will be silenced and current time will be displayed.

In order to cancel set alarm time;

1. To reset the alarm time, press **1** key to activate alarm time symbol (4).
2. Press and hold the key 5 until **"0.00"** is displayed.



### Important

Alarm time will be displayed. If the alarm time and cooking time are set concurrently, shortest time will be displayed.

## Changing alarm sound adjustment

1. Press **'11'** key to activate alarm sound adjustment symbol (8) for alarm volume adjustment.
2. Adjust the desired sound using **'5'** and **'6'** keys.  
» Selected alarm sound level will be displayed as **"b-01"**, **"b-02"** or **"b-03"** on the screen.



# care & cleaning



## Turn OFF at the mains before cleaning.

- Before switching on again ensure that all controls are in the OFF position.
- **Make sure that the oven, grill and hobs are sufficiently cool before you start cleaning.**
- Never mix different cleaning products as different active ingredients may react with unforeseen results.

## Exterior

Use a damp cloth to clean the outside. Never use any sharp instruments, abrasive household cleaner, or detergents for cleaning. For hard stains use suitable washing liquid.

## Burners

The pan supports can be removed and the top burner plate can be cleaned with soapy water and rinsed with a dry cloth.

Wash and rinse the gas burner caps and the pan supports with soapy water. Never wash them in a dishwasher. For the dirt and stains on the burner heads that does not wash off, use a proprietary metal surface cleaner.

## Hob surround

Clean with a cloth wrung out in soapy water. Stubborn stains can be removed with a cream, paste or liquid cleaner. Check that the cleaning agent used is approved by the Vitreous Enamel Development Council.

## Control panel

Wipe over the control panel with a damp cloth and polish with a dry cloth. Do not use oven cleaners or aerosols, scouring pads or abrasive powder for cleaning the plastic knobs or end caps as damage will occur. Do not attempt to remove any of the control knobs from the panel as this may cause damage and is a safety hazard.

## Grill interior

Wipe the grill elements with a damp cloth (ensuring they are sufficiently cool first) to remove any fat splashes. This will prevent fumes from any fat being burned off when the cooker is next used.

## Oven interior

Remove the rod shelves for washing in the sink.

Use a fine steel wool soap pad for removing stubborn stains from the rod shelves and

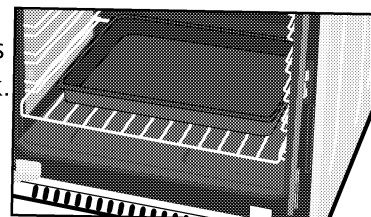

floor of the oven. Take care during cleaning not to damage, bend or dislodge from the surrounding clips the thermostat sensor which is located at the top right hand side of the oven.

Catalytic liners should never require cleaning if very hot temperatures are used regularly.

## Grill / Oven doors

Wipe over the door outer panels with a cloth wrung out in hot soapy water, then after wiping with a cloth wrung out in clean water, dry with a soft clean cloth. Do not use scouring pads or abrasive powder which may scratch the surface. Take care during cleaning not to damage or distort the door seal. Ensure that the door seal is dry after cleaning. Do not lift the door seal.

The inner glass door panels can be removed for cleaning. Open the door fully and gently lift out the glass using extreme care to ensure that the edges of glass are protected. Clean as above, but do not use household detergents, bleach, scouring pads or rust removers. Reinstall the glass panels carefully preventing sudden shocks.

**\* The inner glass is low emissive glass for maximum efficiency and the printed surface must face outwards.**

## Over time...

- Slight discolouration of liners and other surfaces may occur in time. This does not affect the functioning of the appliance.
- Discolourations and marks that occur on the ceramic hob are normal and not a fault.

# trouble shooting

## If the cooker does not work

If the appliance does not operate check whether:

- The power supply is on.
- The fuse has blown/circuit breaker has tripped/main distribution switch has been turned off.
- The temperature control has been set correctly.
- The main oven will not operate if the clock has not been set.
- This cooker must be earthed if in doubt consult a qualified electrician.

If the appliance is still not operating after the above checks, please refer to the section on how to obtain service.

**Please ensure that the above checks have been made as a charge will be made if no fault is found.**

## Performance characteristics when in use

- **When using your appliance for the first few times, an odour and/or smoke may be emitted which is normal** - see page 8.
- It is normal for the metal parts to produce noise when in use, this is due to expansion and contraction.
- When in use, steam may be produced which is normal and not a fault of the cooker.
- At the end of a cooking session, it is normal to have a momentary puff of steam when the oven door is opened. This should disperse in a few seconds.
- If, whilst cooking, steam produced comes in to contact with cool surface's on the outside of the appliance, it will condense and produce water droplets. This is quite normal and is not a fault.

# replacing the oven lamp

## Warning:



Ensure the appliance is switched off at the mains before replacing the lamp to avoid the possibility of electric shock.

## Switch off at the mains.

- 1 Remove the glass cover of the lamp by turning it anti-clockwise.
- 2 Remove the bulb by turning it anti-clockwise.
- 3 After installing the correct bulb, reinstall the glass cover.

Replacement light bulbs can be easily obtained from a good local electrical or DIY store.

# future transportation

Keep the original carton and other packaging material in a safe place. Transport the cooker in its original carton. Follow the instructions that are printed on the carton.

To prevent the accessories inside the oven from damaging the oven door, tape a strip of cardboard onto the inside of the oven door that lines up with the position of the trays. Tape the oven door to the side walls.

## If you do not have the original carton

Take the necessary precautions in order to prevent the exterior panels, and the glass surfaces of the oven from being damaged.

Pack the oven in bubble wrap or thick cardboard and tape it securely in order to prevent damage during transportation.

The oven must be transported upright. Do not place other items on the top of the cooker.

## Recycling

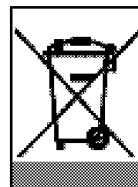

This product bears the selective sorting symbol for waste electrical and electronic equipment (WEEE).

This means that this product must be handled pursuant to European Directive 2002/96/EC in order to be

recycled or dismantled to minimize its impact on the environment.

For further information, please contact your local or regional authorities.

Electronic products not included in the selective sorting process are potentially dangerous for the environment and human health due to the presence of hazardous substances.

# guarantee

---

Your Beko product is guaranteed against the cost of breakdown repairs for twelve months from the date of the original purchase.

## What is covered?

- All repairs necessary as a result of faulty materials, defective components or manufacturing defect.
- The cost of all functional replacement parts.
- The labour costs of a Beko approved repairer to carry out the repair.

## What is not covered?

- Transit or delivery damage
  - Accidental damage
  - Misuse, or abuse.
  - Cabinet or appearance parts, including knobs and flaps
  - Accessory items, including ice trays, scrapers, cutlery baskets,
  - Repairs required as a result of unauthorised repairs or inexperienced installation that fails to meet the requirements contained in the user instruction book.
- Repairs to products used on commercial or non-residential

household premises.

## Important notes.

- The product is guaranteed for domestic household use only.
- The guarantee will be void if the product is installed or used in commercial or non-residential household premises.
- The product must be correctly installed, located and operated in accordance with the instructions contained in the User Instructions Booklet provided.
- Professional Installation by a qualified plumber/electrical appliance installer is recommended for all Washing & Dishwashing Machines and Electric Cookers
- Gas Cookers must only be installed by a Gas Safe (or BORD GAIS) registered Gas Installer.
- The guarantee is given only within the boundaries of the United Kingdom.
- The guarantee is not transferable if the product is resold.
- Beko plc disclaims any liability for incidental or consequential damages.
- The guarantee does not in anyway diminish your statutory or legal rights.

---

## HOW TO OBTAIN SERVICE UNDER THE MANUFACTURERS GUARANTEE

Please keep your purchase receipt or other proof of purchase in a safe place; you will need to have it should the product require attention in the guarantee period

You should also complete the details below; it will help us assist you quicker when requesting service. (The model number is printed on the Instruction Booklet)

Model Number: \_\_\_\_\_

Purchased From: \_\_\_\_\_

Date of purchase: \_\_\_\_\_

For service under guarantee simply telephone the appropriate number below

### LOCATION

### TELEPHONE

UK Mainland & Northern Ireland

Fridges & Freezers

0845 600 4903

Electric Cookers

0845 600 4902

Gas & Dual Fuel Cookers

0845 600 4905

Washing Machines & Dishwashers

0845 600 4906

Republic of Ireland

All Refrigeration, Cooking, Washing & Dishwashing Machines

01 862 3411

Before requesting service please check the trouble-shooting guide in the Operating Instructions as a charge may be levied where no fault is found even though your product may still be under guarantee.

Service once the manufacturers guarantee has expired.

If you have purchased an extended guarantee please refer to the instructions contained within the extended guarantee agreement document. Otherwise please call the above numbers where service can be obtained at a charge.

---

Should you experience any difficulty in obtaining service please call the

**Beko Customer Help-Line on 0845 600 4911**

**Beko House, Caxton Way, Watford, Herts, WD18 8UF, Tel: 0845 600 4911**

Leisure Consumer Products  
36-38 Caxton Way  
Watford  
Herts WD18 8UF  
Tel: 0845 6004916  
Facsimile: 0845 6004922  
[www. Leisurecp.co.uk](http://www.Leisurecp.co.uk)

Part no.485.9210.16/R.AE/02.01.2013